

FISSAGGI

PER RADIATORI

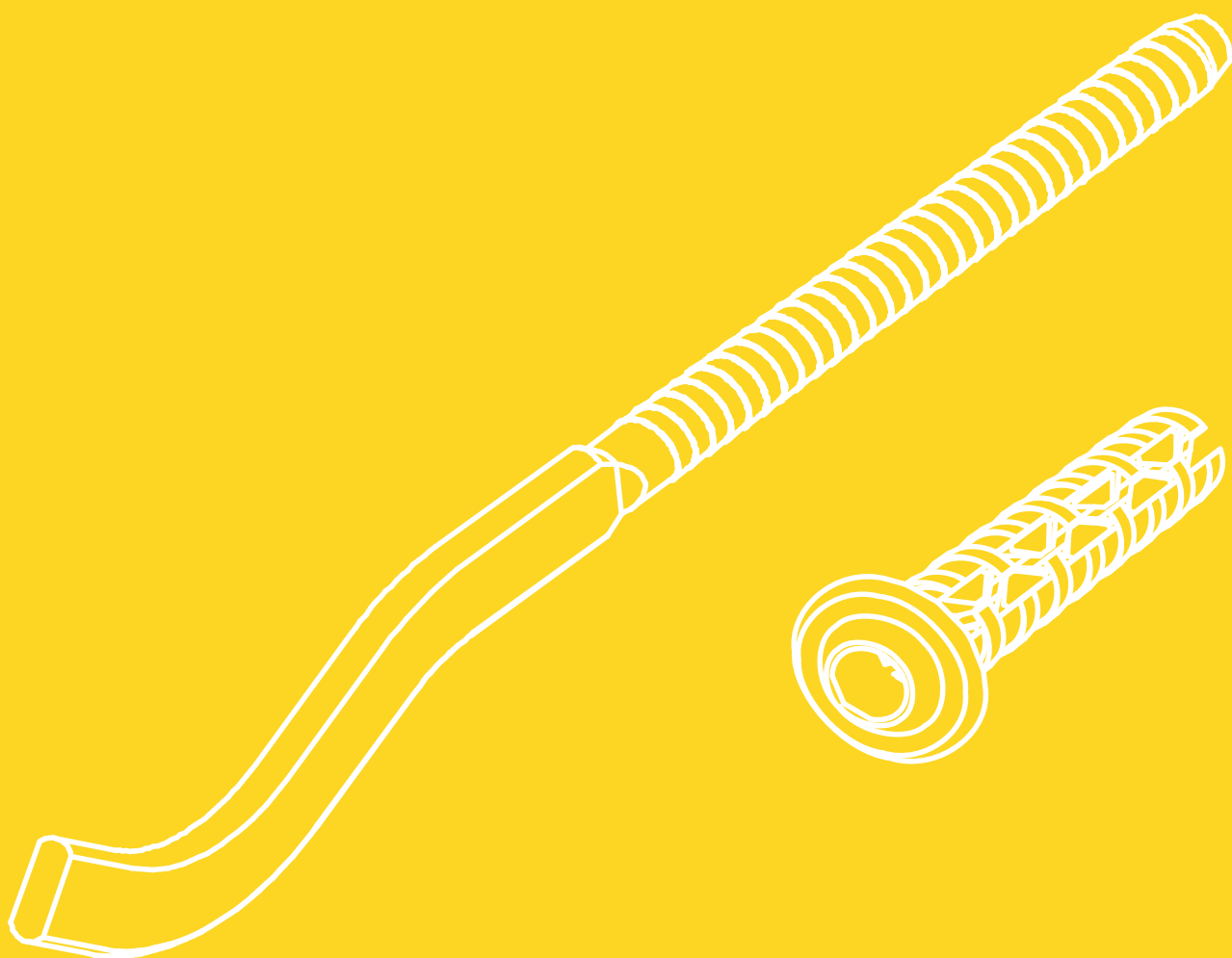

402-V

06MENRA

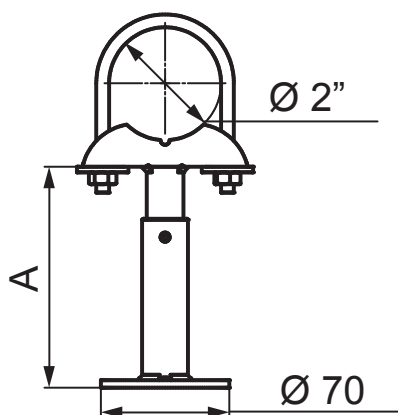
**PIEDINO VERNICIATO**

- Materiale: DD11 EN10111
- Zincatura elettrolitica UNI ISO 2081:2018 sp. 6 ÷ 9 µm

- Verniciatura a polvere bianco RAL 9010 sp. 70 ÷ 80 µm

CARATTERISTICHE: coppia piedini zincati e verniciati per radiatori alluminio, ghisa e acciaio, confezione completa di tasselli e viti per il fissaggio a pavimento.

UTILIZZO: per il sostegno di radiatori a pavimento con possibilità di regolarne l'altezza.

Codice	A [mm]				€ Cad.
40201	110 ÷ 150	250	1	5	55,65

403-V

06MENRA

**COPRI PIEDINO VERNICIATO**

- Materiale: DD11 EN 10111
- Zincatura elettrolitica UNI ISO 2081:2018 sp. 6 ÷ 9 µm

- Verniciatura a polvere bianco RAL 9010 sp. 70 ÷ 80 µm

UTILIZZO: coppia copri piedini zincati e verniciati da usare in abbinamento all'articolo 402-V.

Codice			€ Cad.
40301	1	5	31,50

404-V









06MENRA



MENSOLA VERNICIATA PER RADIATORI IN GHISA

- Materiale: S235JR EN 10025
- Verniciatura a polvere bianco RAL 9010 sp. 70 ÷ 80 µm
- Zincatura elettrolitica UNI ISO 2081:2018 sp. 6 ÷ 9 µm
- Tassello in polietilene

CARATTERISTICHE: coppia di mensole a sezione tonda completa di tasselli per il fissaggio a parete di radiatori tubolari in ghisa.

Codice									€ Cad.
40401	200	11,5	16x90	16	2/3	170	1	25	7,90
40402	230	11,5	16x90	16	3/4	91	1	25	8,56
40403	260	11,5	16x90	16	5/6	65	1	25	10,20

404-Z









06MENRA



MENSOLA ZINCATA PER RADIATORI IN GHISA

- Materiale: S235JR EN 10025
- Tassello in polietilene
- Zincatura elettrolitica UNI ISO 2081:2018 sp. 6 ÷ 9 µm

CARATTERISTICHE: coppia di mensole a sezione tonda completa di tasselli per il fissaggio a parete di radiatori tubolari in ghisa.

Codice									€ Cad.
40404	200	11,5	16x90	16	2/3	170	1	25	7,01
40405	230	11,5	16x90	16	3/4	91	1	25	7,46
40406	260	11,5	16x90	16	5/6	65	1	25	9,88







406-V

06MENRA

**MENSOLA SCHIACCIATA VERNICIATA PER RADIATORI TUBOLARI Ø60**

- Materiale: S235JR EN 10025
- Verniciatura a polvere bianco RAL 9010 sp. 70 ÷ 80 µm
- Zincatura elettrolitica UNI ISO 2081:2018 sp. 6 ÷ 9 µm
- Tassello in polietilene

CARATTERISTICHE: coppia di mensole a sezione piatta completa di tasselli per il fissaggio a parete di radiatori tubolari con mozzo ø60 mm.

Codice	mm	Ø (mm)							€ Cad.
40601	175	8,5	12x73	12	2/3	57	1	25	7,01
40602	195	8,5	12x73	12	3/4	40	1	25	7,23
40603	250	8,5	12x73	12	5/6	23	1	25	8,24







408-V

06MENRA

**MENSOLA VERNICIATA PER RADIATORI TUBOLARI Ø53**

- Materiale: S235JR EN 10025
- Verniciatura a polvere bianco RAL 9010 sp. 70 ÷ 80 µm
- Zincatura elettrolitica UNI ISO 2081:2018 sp. 6 ÷ 9 µm
- Tassello in polietilene

CARATTERISTICHE: coppia di mensole a sezione tonda completa di tasselli per il fissaggio a parete di radiatori tubolari con mozzo ø53 mm.

Codice	mm	Ø (mm)							€ Cad.
40801	200	8,5	12x73	12	2/3	35	1	25	7,31
40802	220	8,5	12x73	12	3/4	33	1	25	7,49
40803	270	11,5	16x73	16	5/6	65	1	25	12,03

410-V









06MENRA



MENSOLA VERNICIATA PER RADIATORI TUBOLARI Ø60

- Materiale: S235JR EN 10025
- Verniciatura a polvere bianco RAL 9010 sp. 70 ÷ 80 µm
- Zincatura elettrolitica UNI ISO 2081:2018 sp. 6 ÷ 9 µm
- Tassello in polietilene

CARATTERISTICHE: coppia di mensole a sezione tonda completa di tasselli per il fissaggio a parete di radiatori tubolari con mozzo Ø60 mm.

Codice									€ Cad.
41001	200	8,5	12x73	12	2/3	35	1	25	7,31
41002	220	8,5	12x73	12	3/4	33	1	25	7,49
41003	270	11,5	16x73	16	5/6	65	1	25	12,03

414-V









06MENRA



MENSOLA PLASTIFICATA PER RADIATORI IN ALLUMINIO

- Materiale: S235JR EN 10025
- Verniciatura a polvere bianco RAL 9010 sp. 1 mm
- Zincatura elettrolitica UNI ISO 2081:2018 sp. 6 ÷ 9 µm
- Tassello in polietilene

CARATTERISTICHE: coppia di mensole a sezione tonda completa di tasselli per il fissaggio a parete di radiatori in alluminio.

Codice									€ Cad.
41401	170	7	10x73	10		34	1	50	4,76

414-V-S

06MENRA

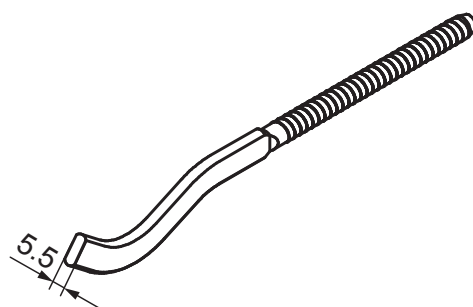
**MENSOLA SCHIACCIATA PLASTIFICATA PER RADIATORI IN ALLUMINIO**

- Materiale: S235JR EN 10025
- Zincatura elettrolitica UNI ISO 2081:2018 sp. 6 ÷ 9 µm
- Plastificato bianco RAL 9010 sp. 1 mm
- Tassello in polietilene

CARATTERISTICHE: coppia di mensole a sezione piatta completa di tasselli per il fissaggio a parete di radiatori in alluminio.

Codice	mm	∅ (mm)		mm		C		€ Cad.
41402	170	7	10x73	10	34	1	50	4,98

415-V

06MENRA

**MENSOLA PLASTIFICATA PER RADIATORI IN ALLUMINIO**

- Materiale: S235JR EN 10025
- Zincatura elettrolitica UNI ISO 2081:2018 sp. 6 ÷ 9 µm
- Plastificato bianco RAL 9010 sp. 1 mm
- Tassello in polietilene

CARATTERISTICHE: coppia di mensole a sezione tonda completa di tasselli per il fissaggio a parete di radiatori in alluminio.

Codice	mm	∅ (mm)		mm		C		€ Cad.
41501	170	8,5	12x73	12	58	1	50	4,91
41503	220	8,5	12x73	12	35	1	50	6,71





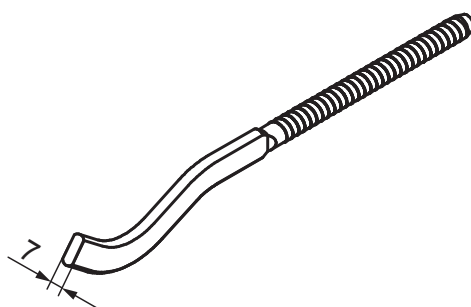

415-V-S

06MENRA

**MENSOLA PLASTIFICATA SCHIACCIATA PER RADIATORI IN ALLUMINIO**

- Materiale: S235JR EN 10025
- Zincatura elettrolitica UNI ISO 2081:2018 sp. 6 ÷ 9 µm
- Plastificato bianco RAL 9010 sp. 1 mm
- Tassello in polietilene

CARATTERISTICHE: coppia di mensole a sezione piatta completa di tasselli per il fissaggio a parete di radiatori in alluminio.

Codice								€ Cad.
41502	170	8,5	12x73	12	58	1	50	5,20
41504	220	8,5	12x73	12	35	1	50	6,90





501

06MENRA

**MENSOLA ZINCATA A MURARE PER RADIATORI IN GHISA E ACCIAIO**

- Materiale: DX51 - Z140 EN 10142
- Zincatura elettrolitica UNI ISO 2081:2018 sp. 6 ÷ 9 µm

CARATTERISTICHE: coppia di mensole per radiatori in ghisa e acciaio con flangia da 1"-1.1/4"

Codice			Larghezza [mm]			€ Cad.
50101	190	1" / 1.1/4"	9	1,5	100	2,10
50102	230	1" / 1.1/4"	9	1,5	100	2,24
50103	260	1" / 1.1/4"	9	1,5	100	2,40
50104	290	1" / 1.1/4"	9	1,5	100	2,88

06MENRA



MENSOLA ZINCATA A MURARE PER RADIATORI IN ALLUMINIO

- Materiale: DX51 - Z140 EN 10142
- Zincatura elettrolitica UNI ISO 2081:2018 sp. 6 ÷ 9 µm

CARATTERISTICHE: coppia di mensole per radiatori in alluminio con flangia da 1"-1.1/4"

Codice		Ø			€ Cad.
50301	180	1" / 1.1/4"	2	100	1,94
50302	220	1" / 1.1/4"	2	100	2,08