

COLLARI PER TUBI

IN ACCIAIO INOX AISI 304 (A2)

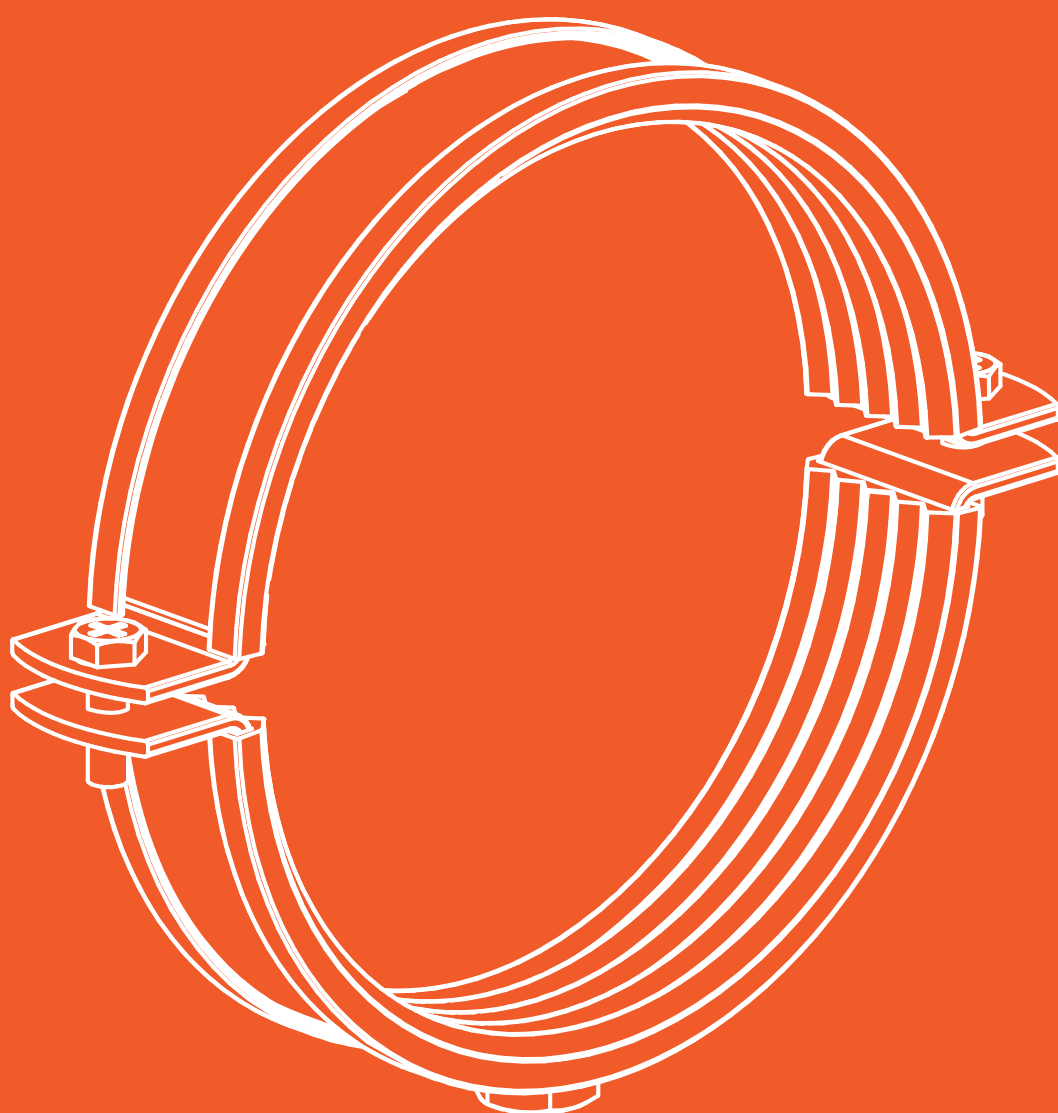

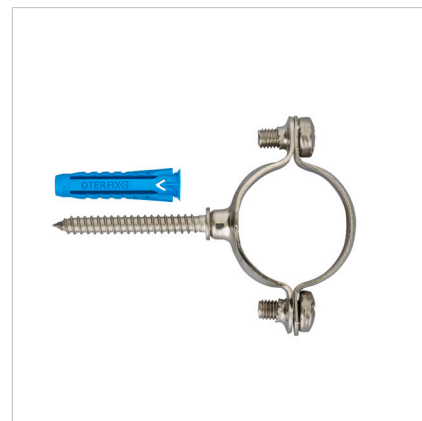



08COLF4

**COLLARE LEGGERO CON PERNO E TASSELLO**

- Materiale: collare e perno in acciaio inox AISI 304 EN 10088
- Tassello in nylon

UTILIZZO: il collare leggero è adatto per fissare tubi in rame e tubi a pressare. Le due parti che compongono il collare sono fornite montate.

Codice	Ø	□ [mm]					€ Cad.
81212	12	SS:10x0,9 - SI:13x1,2	M6	M6x45	6x30	10/100	4,70
81215	15	SS:10x0,9 - SI:13x1,2	M6	M6x45	6x30	10/100	4,78
81218	18-3/8"	SS:10x0,9 - SI:13x1,2	M6	M6x45	6x30	10/100	4,97
81222	22-1/2"	SS:10x0,9 - SI:13x1,2	M6	M6x45	6x30	10/100	5,13
81228*	28-3/4"	SS:10x0,9 - SI:13x1,2	M6	M6x45	6x30	10/100	5,03

SS = STAFFA SUPERIORE SI = STAFFA INFERIORE

* PRODOTTO DISPONIBILE FINO AD ESAURIMENTO SCORTE

826-I

08COLF4

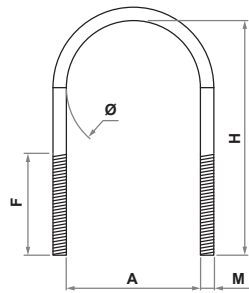

CAVALLOTTO/U-BOLT CON DADI E RONDELLE

• Materiale: acciaio inox AISI 304 EN 10088

CARATTERISTICHE: nella confezione sono compresi due dadi esagonali UNI 5588 (DIN 934) in acciaio inox AISI 304 (A2) e due rondelle piane UNI 6592 in acciaio inox AISI 304 (INOX A2).

UTILIZZO: per il fissaggio di tubazioni sui profilati leggeri 30x15 e 32x20.

Codice	Ø	M x F	H x A [mm]		€ Cad.
82603	3/8"	M6 x 16	36 x 18	50	SR
82604	1/2"	M6 x 18	40 x 22	50	SR
82605	3/4"	M6 x 18	45 x 27	50	SR
82606	1"	M6 x 18	52 x 34	50	SR
82607	1.1/4"	M6 x 18	61 x 43	25	SR
82608	1.1/2"	M8 x 28	70 x 49	25	SR
82609	2"	M8 x 28	82 x 61	25	SR
82610	2.1/2"	M8 x 28	98 x 77	25	SR
82611	3"	M8 x 28	110 x 89	25	SR
82612	3.1/2"	M8 x 35	127 x 102	10	SR
82613	4"	M8 x 35	139 x 115	10	SR
82614	5"	M8 x 35	165 x 140	10	SR
82615	6"	M10 x 45	196 x 168	10	SR

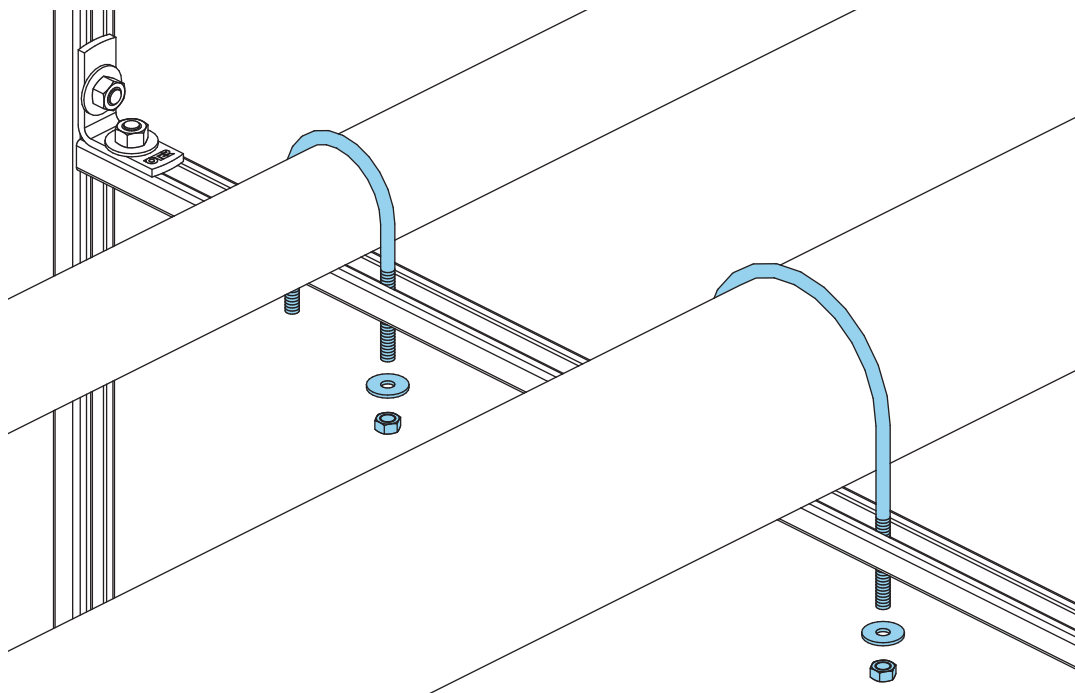





08COLF4

**COLLARE PESANTE CON PERNO E TASSELLO**

• Materiale: collare e perno in acciaio inox AISI 304 EN 10088

• Tassello in nylon

CARATTERISTICHE: attacco collare elettrosaldato a proiezione, fornito con tassello in nylon e confezionato in busta singola.**UTILIZZO:** per il fissaggio di tubazioni a parete ed a solaio.

Codice	Ø	Ø+Ø	□ [mm]						€ Cad.
83203	3/8"	16÷20	20x2,0	M8	M8x80	10x50	300	100	6,26
83204	1/2"	20÷24	20x2,0	M8	M8x80	10x50	300	100	6,60
83205	3/4"	25÷30	20x2,0	M8	M8x80	10x50	300	100	6,75
83206	1"	32÷36	20x2,0	M8	M8x80	10x50	300	100	6,94
83207	1.1/4"	38÷44	20x2,0	M8	M8x80	10x50	300	50	7,26
83208	1.1/2"	46÷50	20x2,0	M8	M8x80	10x50	300	50	7,60
83209	2"	58÷62	20x2,0	M8	M8x80	10x50	300	50	8,30
83210	2.1/2"	74÷80	30x2,5	M10	M10x100	12x60	300	25	16,49
83211	3"	84÷89	30x2,5	M10	M10x100	12x60	300	25	17,36
83213	4"	112÷118	30x2,5	M10	M10x100	12x60	300	25	20,52
83214	5"	134÷138	30x2,5	M10	M10x100	12x60	400	25	28,61
83215	6"	164÷172	30x2,5	M10	M10x100	12x60	400	25	32,05

837-I

08COLF4





COLLARE PESANTE

• Materiale: acciaio inox AISI 304 EN 10088

CARATTERISTICHE: attacco collare elettrosaldato a proiezione e confezionato in busta singola.

UTILIZZO: per il fissaggio di tubazioni a parete ed a solaio.

Codice	Ø	Ø÷Ø	□ [mm]				€ Cad.
83703	3/8"	16÷20	20x2,0	M8	300	100	4,73
83704	1/2"	20÷24	20x2,0	M8	300	100	4,90
83705	3/4"	25÷30	20x2,0	M8	300	100	4,99
83706	1"	32÷36	20x2,0	M8	300	100	5,53
83707	1.1/4"	38÷44	20x2,0	M8	300	50	5,95
83708	1.1/2"	46÷50	20x2,0	M8	300	50	6,39
83709	2"	58÷62	20x2,0	M8	300	50	6,80
83710	2.1/2"	74÷80	30x2,5	M10	300	25	13,36
83711	3"	84÷89	30x2,5	M10	300	25	14,20
83713	4"	112÷118	30x2,5	M10	300	25	16,82
83714	5"	134÷138	30x2,5	M10	400	25	25,18
83715	6"	164÷172	30x2,5	M10	400	25	28,61
83716	8"(*)	220	40x4,0	M12	500	10	58,66
83717	10"(*)	250	40x4,0	M12	600	10	76,30

(*) verificare sempre disponibilita' e tempi di consegna

08COLF4







COLLARE ISOFONICO CON PERNO E TASSELLO

- Materiale: collare e perno in acciaio inox AISI 304 EN 10088
- Tassello in nylon

CARATTERISTICHE: attacco collare elettrosaldato a proiezione, il rivestimento interno è in EPDM, durezza 85 shore. Temperatura di utilizzo -30° / +100°. Fornito con tassello in nylon e confezionato in busta singola.

UTILIZZO: garantisce la continuità della coibentazione di un tubo, abbatte il livello acustico trasmesso dal tubo al supporto.

Codice	Ø	□ (mm)						€ Cad.
83220	3/8"	20x2,0	M8	M8x80	10x50	300	50	7,78
83221	1/2"	20x2,0	M8	M8x80	10x50	300	50	8,40
83222	3/4"	20x2,0	M8	M8x80	10x50	300	50	8,46
83223	1"	20x2,0	M8	M8x80	10x50	300	50	9,05
83224	1.1/4"	20x2,0	M8	M8x80	10x50	300	25	9,91
83225	1.1/2"	20x2,0	M8	M8x80	10x50	300	25	10,78
83226	2"	20x2,0	M8	M8x80	10x50	300	25	11,45
83227	2.1/2"	30x2,5	M10	M10x100	12x60	300	10	23,42
83228	3"	30x2,5	M10	M10x100	12x60	300	10	24,96
83229	4"	30x2,5	M10	M10x100	12x60	300	10	30,33
83230	5"	30x2,5	M10	M10x100	12x60	400	10	31,45
83231	6"	30x2,5	M10	M10x100	12x60	400	10	35,25

837-IG

08COLF4







COLLARE ISOFONICO

• Materiale: collare in acciaio inox AISI 304 EN 10088

CARATTERISTICHE: attacco collare elettrosaldato a proiezione, il rivestimento interno è in EPDM, durezza 85 shore. Temperatura di utilizzo -30° / +100°. Confezionato in busta singola.

UTILIZZO: garantisce la continuità della coibentazione di un tubo, abbatte il livello acustico trasmesso dal tubo al supporto.

Codice	Ø	 [mm]				€ Cad.
83720	3/8"	20x2,0	M8	300	50	6,65
83721	1/2"	20x2,0	M8	300	50	6,92
83722	3/4"	20x2,0	M8	300	50	7,44
83723	1"	20x2,0	M8	300	50	8,14
83724	1.1/4"	20x2,0	M8	300	25	8,84
83725	1.1/2"	20x2,0	M8	300	25	9,81
83726	2"	20x2,0	M8	300	25	10,68
83727	2.1/2"	30x2,5	M10	300	10	22,25
83728	3"	30x2,5	M10	300	10	23,62
83729	4"	30x2,5	M10	300	10	29,24
83730	5"	30x2,5	M10	400	10	30,29
83731	6"	30x2,5	M10	400	10	32,06
83732	8"(*)	40x4,0	M12	500	10	83,69
83733	10"(*)	40x4,0	M12	600	10	101,38

(*) verificare sempre disponibilita' e tempi di consegna

08COLF4



COLLARE PER CANNE FUMARIE CON PERNO E TASSELLO

- Materiale: collare e perno in acciaio inox AISI 304 EN 10088
- Tassello in nylon

CARATTERISTICHE: fornito con tassello in nylon e confezionato in busta singola. La cerniera consente una facilità e rapidità di aggancio del tubo, infatti il collare si blocca avvitando una sola vite.

UTILIZZO: per fissare tubi di scarico del fumo.

Codice	Ø	□ (mm)						€ Cad.
88101	60	25x1,5	M8	M8x200	10x50	150	25	17,30
88102	80	25x1,5	M8	M8x200	10x50	150	25	17,67
88103	100	25x1,5	M8	M8x200	10x50	150	25	19,10
88104	110	25x1,5	M8	M8x200	10x50	150	25	21,41
88105	120	25x1,5	M8	M8x200	10x50	150	25	22,32
88106	125	25x1,5	M8	M8x200	10x50	150	25	24,45
88107	130	25x1,5	M8	M8x200	10x50	150	25	26,22
88108	140	25x1,5	M8	M8x200	10x50	150	25	30,87
88109	150	25x1,5	M8	M8x200	10x50	150	25	34,44
88110	160	25x1,5	M8	M8x200	10x50	150	25	36,92
88111	180	25x1,5	M8	M8x200	10x50	150	10	64,94
88112	200	25x1,5	M8	M8x200	10x50	150	10	74,06
88113	220	25x1,5	M8	M8x200	10x50	150	10	84,75
88114	250	25x1,5	M8	M8x200	10x50	150	10	95,82
88115	300	25x1,5	M8	M8x200	10x50	150	10	117,40

855-I

08COLF4

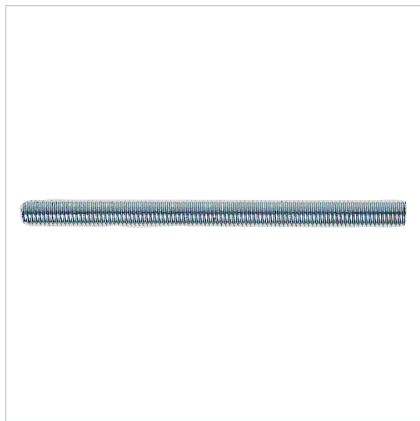
**BARRA FILETTATA**

• Materiale: acciaio inox AISI 304 EN 10088

CARATTERISTICHE: la barra filettata ha passo metrico.

UTILIZZO: per creare connessioni tra profilati del sistema di staffaggio (leggero/pesante) e collari o per realizzare pendinature.

Codice	Ø	L [m]	 (P2)	€ Cad.
85512	M8	1	10	19,99
85513	M10	1	10	32,82

857-I

08COLF4

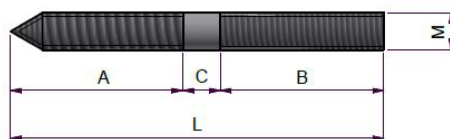



KIT ANCORAGGIO COLLARI

- Materiale: perno e dado in acciaio inox AISI 304 EN 10088
- Tassello in nylon

CARATTERISTICHE: il kit di ancoraggio per i collari è costituito da un perno con il doppio filetto (metrico e truciolare), un dado ed un corpo tassello. Confezionato in busta singola.

UTILIZZO: per l'installazione dei collari direttamente a parete e/o solaio.

Codice		MxL	A x B x C [mm]		€ Cad.
85711	10x50	M8x80	35x45x-	100	3,61
85713	10x50	M8x200	120x60x20	50	7,51
85714	12x60	M10x100	40x60x-	50	7,18

1025-I

08COLF4

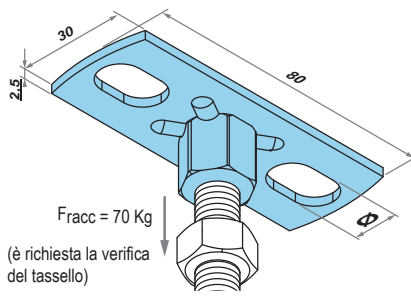

PIASTRA RETTANGOLARE DI FISSAGGIO

- Materiale: Acciaio inox AISI 304 EN 10088

CARATTERISTICHE: l'imbocco metrico è saldato a proiezione.

UTILIZZO: per il fissaggio di collari sia a parete che a solaio/pavimento. La piastra è dotata di due fori asolati, per l'inserimento di due ancoranti, e di un imbocco centrale filettato M10, per l'avvitamento di una barra filettata a passo metrico.

Codice		asole [mm] / piastra		€ Cad.
M2513	M10	12x7,0	100	7,18