

COLLARI PER TUBI

IN ACCIAIO INOX AISI 304 (A2)

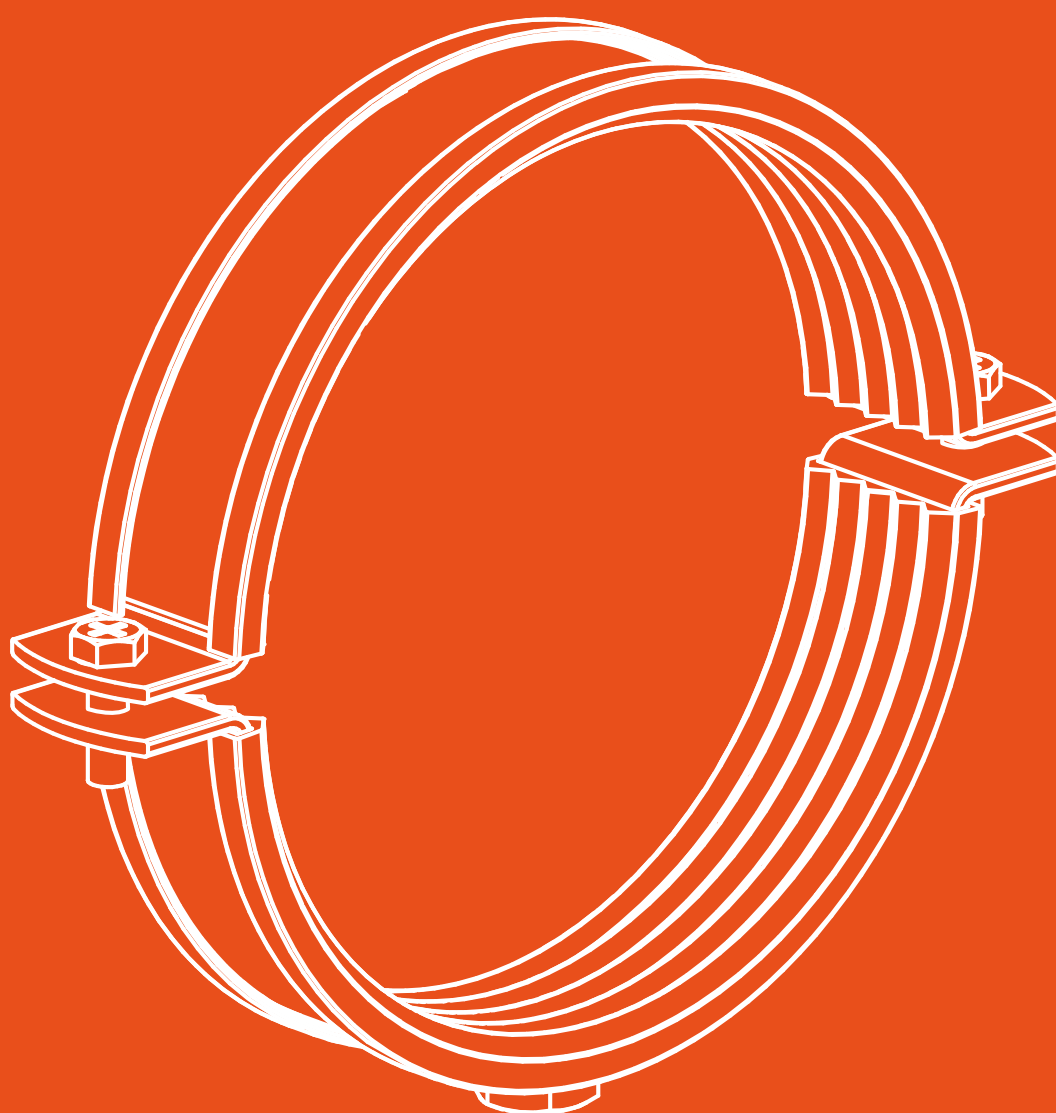

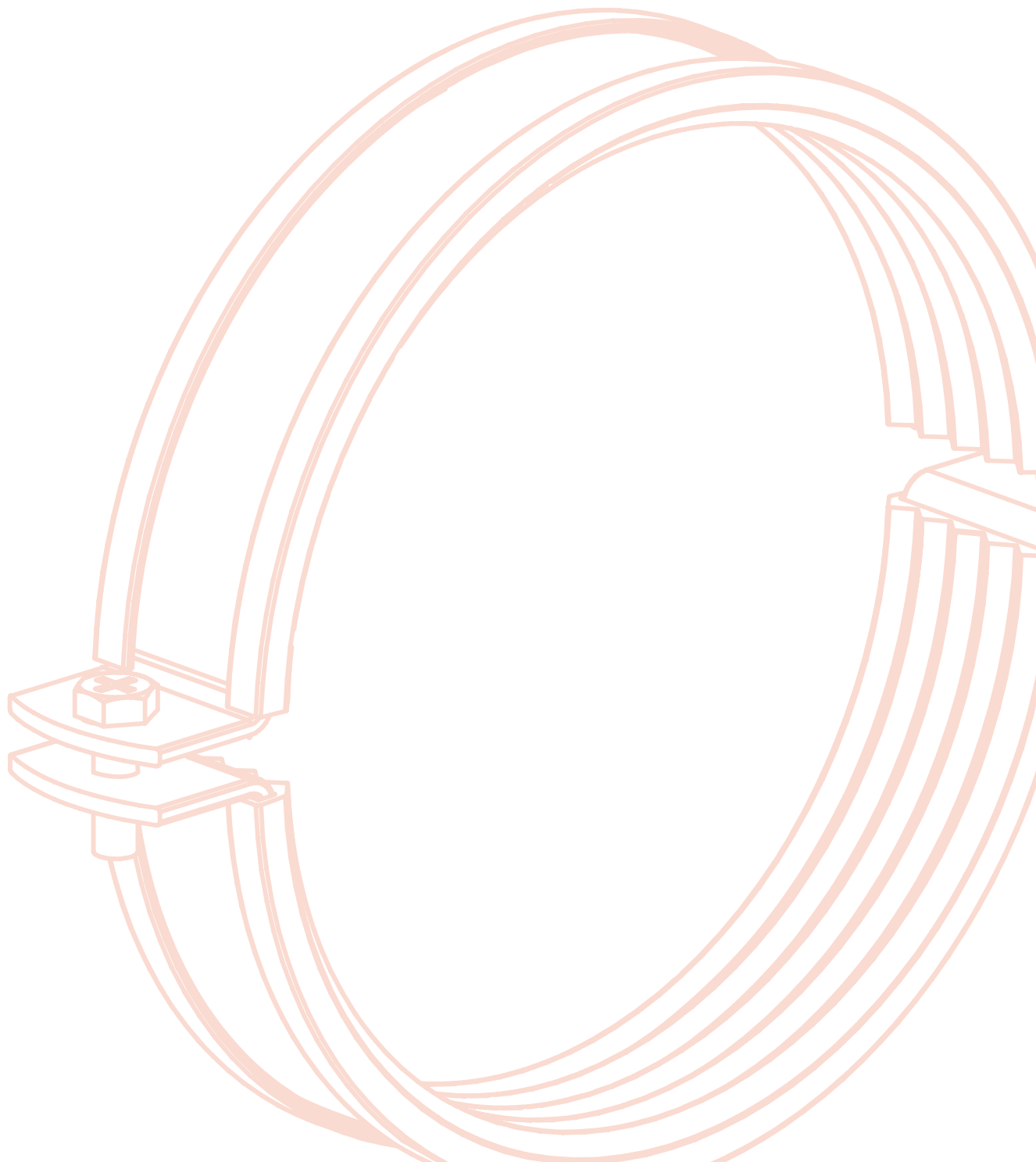





08COLF4



COLLARE LEGGERO CON PERNO E TASSELLO

• Materiale: collare e perno in acciaio inox AISI 304 EN 10088 • Tassello in nylon

UTILIZZO: il collare leggero è adatto per fissare tubi in rame e tubi a pressare. Le due parti che compongono il collare sono fornite montate.

CODICE	Ø	□ [mm]					€ Cad.
81212	12	SS:10x0,9 - SI:13x1,2	M6	M6x45	6x30	10/100	4,11
81215	15	SS:10x0,9 - SI:13x1,2	M6	M6x45	6x30	10/100	4,18
81218	18-3/8"	SS:10x0,9 - SI:13x1,2	M6	M6x45	6x30	10/100	4,34
81222	22-1/2"	SS:10x0,9 - SI:13x1,2	M6	M6x45	6x30	10/100	4,48
81228	28-3/4"	SS:10x0,9 - SI:13x1,2	M6	M6x45	6x30	10/100	4,79

SS = STAFFA SUPERIORE SI = STAFFA INFERIORE



08COLF4



KIT PERNO E TASSELLO PER COLLARE LEGGERO

• Materiale: acciaio inox AISI 304 EN 10088

CARATTERISTICHE: il perno da un'estremità presenta una filettatura metrica per l'avvitamento di un collare leggero e dall'altra estremità ha una filettatura truciolare da avvitare nel corpo del tassello.

CODICE				€ Cad.
81276	M6x76	8x40	10/100	
81290	M6x90	8x40	10/100	1,33

826-I

08COLF4

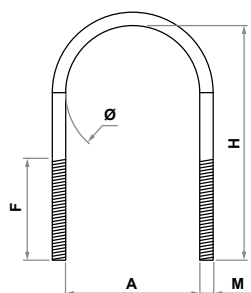

CAVALLOTTO/U-BOLT CON DADI E RONDELLE

• Materiale: acciaio inox AISI 304 EN 10088

CARATTERISTICHE: nella confezione sono compresi due dadi esagonali UNI 5588 (DIN 934) in acciaio inox AISI 304 (A2) e due rondelle piane UNI 6592 in acciaio inox AISI 304 (A2).

UTILIZZO: per il fissaggio di tubazioni sui profilati leggeri 30x15 e 32x20.

CODICE	Ø	M x F	H x A [mm]		€ Cad.
82603	3/8"	M6 x 16	36 x 18	50	4,64
82604	1/2"	M6 x 18	40 x 22	50	4,79
82605	3/4"	M6 x 18	45 x 27	50	4,93
82606	1"	M6 x 18	52 x 34	50	5,22
82607	1.1/4"	M6 x 18	61 x 43	25	5,52
82608	1.1/2"	M8 x 28	70 x 49	25	8,36
82609	2"	M8 x 28	82 x 61	25	11,43
82610	2.1/2"	M8 x 28	98 x 77	25	13,29
82611	3"	M8 x 28	110 x 89	25	14,41
82612	3.1/2"	M8 x 35	127 x 102	10	22,41
82613	4"	M8 x 35	139 x 115	10	20,08
82614	5"	M8 x 35	165 x 140	10	26,12
82615	6"	M10 x 45	196 x 168	10	33,75

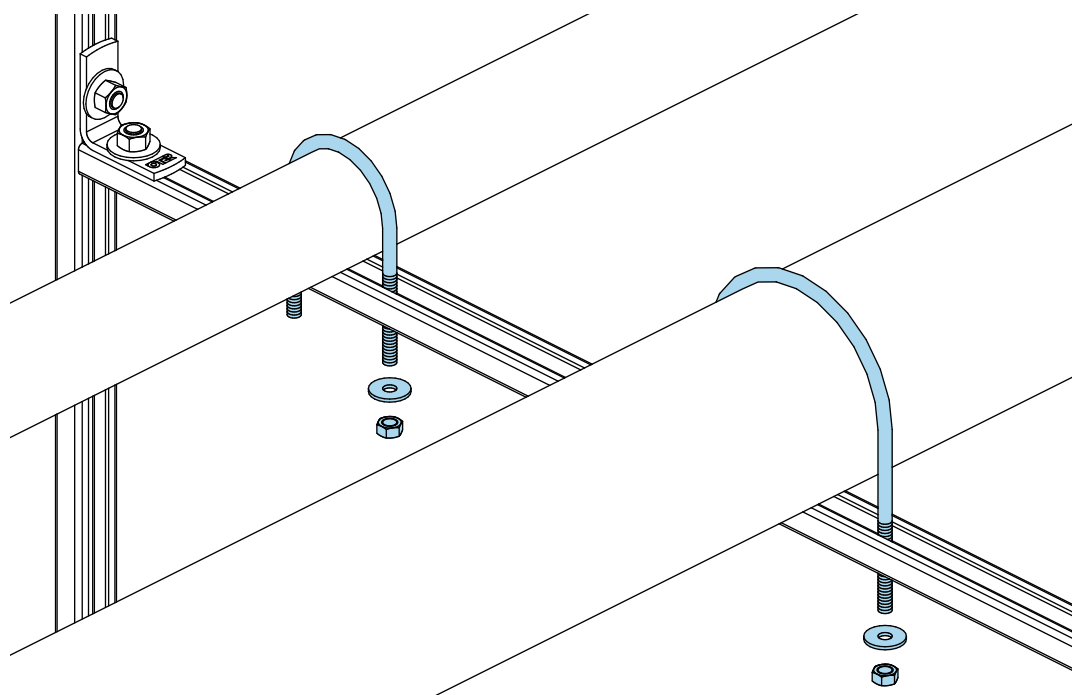

08COLF4







COLLARE PESANTE CON PERNO E TASSELLO

• Materiale: collare e perno in acciaio inox AISI 304 EN 10088

CARATTERISTICHE: attacco collare elettrosaldato a proiezione, fornito con tassello in nylon e confezionato in busta singola.

UTILIZZO: per il fissaggio di tubazioni a parete ed a solaio.

CODICE	Ø	Ø±Ø	□ [mm]						€ Cad.
83203	3/8"	16÷20	20x2,0	M8	M8x80	10x50	300	100	5,47
83204	1/2"	20÷24	20x2,0	M8	M8x80	10x50	300	100	5,77
83205	3/4"	25÷30	20x2,0	M8	M8x80	10x50	300	100	5,90
83206	1"	32÷36	20x2,0	M8	M8x80	10x50	300	100	6,06
83207	1.1/4"	38÷44	20x2,0	M8	M8x80	10x50	300	50	6,34
83208	1.1/2"	46÷50	20x2,0	M8	M8x80	10x50	300	50	6,64
83209	2"	58÷62	20x2,0	M8	M8x80	10x50	300	50	7,25
83210	2.1/2"	74÷80	30x2,5	M10	M10x100	12x60	300	25	14,41
83211	3"	84÷89	30x2,5	M10	M10x100	12x60	300	25	15,17
83213	4"	112÷118	30x2,5	M10	M10x100	12x60	300	25	17,93
83214	5"	134÷138	30x2,5	M10	M10x100	12x60	400	25	25,00
83215	6"	164÷172	30x2,5	M10	M10x100	12x60	400	25	28,00

837-I

08COLF4





COLLARE PESANTE

• Materiale: acciaio inox AISI 304 EN 10088

CARATTERISTICHE: attacco collare elettrosaldato a proiezione e confezionato in busta singola.

UTILIZZO: per il fissaggio di tubazioni a parete ed a solaio.

CODICE	Ø	Ø÷Ø	□ [mm]				€ Cad.
83703	3/8"	16÷20	20x2,0	M8	300	100	4,13
83704	1/2"	20÷24	20x2,0	M8	300	100	4,28
83705	3/4"	25÷30	20x2,0	M8	300	100	4,36
83706	1"	32÷36	20x2,0	M8	300	100	4,83
83707	1.1/4"	38÷44	20x2,0	M8	300	50	5,20
83708	1.1/2"	46÷50	20x2,0	M8	300	50	5,58
83709	2"	58÷62	20x2,0	M8	300	50	5,94
83710	2.1/2"	74÷80	30x2,5	M10	300	25	11,67
83711	3"	84÷89	30x2,5	M10	300	25	12,41
83713	4"	112÷118	30x2,5	M10	300	25	14,70
83714	5"	134÷138	30x2,5	M10	400	25	22,00
83715	6"	164÷172	30x2,5	M10	400	25	25,00
83716	8"(*)	219÷225	40x4,0	M12	500	10	51,25
83717	10"(*)	273÷279	40x4,0	M12	600	10	SR

(*) verificare sempre disponibilita' e tempi di consegna

08COLF4







COLLARE ISOFONICO CON PERNO E TASSELLO

• Materiale: collare e perno in acciaio inox AISI 304 EN 10088

CARATTERISTICHE: attacco collare elettrosaldato a proiezione, il rivestimento interno è in EPDM. Fornito con tassello in nylon e confezionato in busta singola.

UTILIZZO: garantisce la continuità della coibentazione di un tubo, abbatte il livello acustico trasmesso dal tubo al supporto.

CODICE	Ø	□ (mm)						€ Cad.
83220	3/8"	20x2,0	M8	M8x80	10x50	300	50	6,80
83221	1/2"	20x2,0	M8	M8x80	10x50	300	50	7,34
83222	3/4"	20x2,0	M8	M8x80	10x50	300	50	7,39
83223	1"	20x2,0	M8	M8x80	10x50	300	50	7,91
83224	1.1/4"	20x2,0	M8	M8x80	10x50	300	25	8,66
83225	1.1/2"	20x2,0	M8	M8x80	10x50	300	25	9,42
83226	2"	20x2,0	M8	M8x80	10x50	300	25	10,00
83227	2.1/2"	30x2,5	M10	M10x100	12x60	300	10	20,46
83228	3"	30x2,5	M10	M10x100	12x60	300	10	21,81
83229	4"	30x2,5	M10	M10x100	12x60	300	10	26,50
83230	5"	30x2,5	M10	M10x100	12x60	400	10	27,48
83231	6"	30x2,5	M10	M10x100	12x60	400	10	30,80

837-IG





08COLF4

**COLLARE ISOFONICO**

• Materiale: collare in acciaio inox AISI 304 EN 10088

CARATTERISTICHE: attacco collare elettrosaldato a proiezione, il rivestimento interno è in EPDM. Fornito con tassello in nylon e confezionato in busta singola.

UTILIZZO: garantisce la continuità della coibentazione di un tubo, abbatte il livello acustico trasmesso dal tubo al supporto.

CODICE	Ø	 [mm]				€ Cad.
83720	3/8"	20x2,0	M8	300	50	5,81
83721	1/2"	20x2,0	M8	300	50	6,05
83722	3/4"	20x2,0	M8	300	50	6,50
83723	1"	20x2,0	M8	300	50	7,11
83724	1.1/4"	20x2,0	M8	300	25	7,72
83725	1.1/2"	20x2,0	M8	300	25	8,57
83726	2"	20x2,0	M8	300	25	9,33
83727	2.1/2"	30x2,5	M10	300	10	19,44
83728	3"	30x2,5	M10	300	10	20,64
83729	4"	30x2,5	M10	300	10	25,55
83730	5"	30x2,5	M10	400	10	26,47
83731	6"	30x2,5	M10	400	10	28,01
83732	8"(*)	40x4,0	M12	500	10	73,12
83733	10"(*)	40x4,0	M12	600	10	88,58

(*) verificare sempre disponibilita' e tempi di consegna



COLLARE PER CANNE FUMARIE CON PERNO E TASSELLO

• Materiale: Collare e perno in acciaio inox AISI 304 EN 10088

CARATTERISTICHE: fornito con tassello in nylon e confezionato in busta singola. La cerniera consente una facilità e rapidità di aggancio del tubo, infatti il collare si blocca avvitando una sola vite.

UTILIZZO: per fissare tubi di scarico del fumo.

CODICE	Ø	∇ (mm)						€ Cad.
88101	60	25x1,5	M8	M8x200	10x50	150	25	15,12
88102	80	25x1,5	M8	M8x200	10x50	150	25	15,44
88103	100	25x1,5	M8	M8x200	10x50	150	25	16,69
88104	110	25x1,5	M8	M8x200	10x50	150	25	18,71
88105	120	25x1,5	M8	M8x200	10x50	150	25	19,50
88106	125	25x1,5	M8	M8x200	10x50	150	25	21,36
88107	130	25x1,5	M8	M8x200	10x50	150	25	22,91
88108	140	25x1,5	M8	M8x200	10x50	150	25	26,97
88109	150	25x1,5	M8	M8x200	10x50	150	25	30,09
88110	160	25x1,5	M8	M8x200	10x50	150	25	32,26
88111	180	25x1,5	M8	M8x200	10x50	150	10	56,74
88112	200	25x1,5	M8	M8x200	10x50	150	10	64,71
88113	220	25x1,5	M8	M8x200	10x50	150	10	74,05
88114	250	25x1,5	M8	M8x200	10x50	150	10	83,72
88115	300	25x1,5	M8	M8x200	10x50	150	10	102,58

855-I

08COLF4

**BARRA FILETTATA**

• Materiale: acciaio inox AISI 304 EN 10088

CARATTERISTICHE: la barra filettata ha passo metrico.

UTILIZZO: per creare connessioni tra profilati del sistema di staffaggio (leggero/pesante) e collari o per realizzare pendinature.

CODICE	Ø	L [m]	 (A2)	€ Cad.
85512	M8	1	10	17,47
85513	M10	1	10	28,68

08COLF4

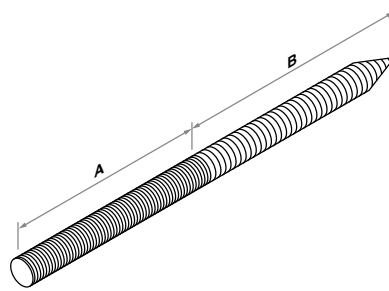

KIT ANCORAGGIO COLLARI

• Materiale: perno e dado in acciaio inox AISI 304 EN 10088

CARATTERISTICHE: il kit di ancoraggio per i collari è costituito da un perno con il doppio filetto (metrico e truciolare), un dado ed un corpo tassello. Confezionato in busta singola.

UTILIZZO: per l'installazione dei collari direttamente a parete e/o solaio.

CODICE		MxL	AxB[mm]		€ Cad.
85711	10x50	M8x80	30x50	100	3,15
85713	10x50	M8x200	120x80	50	6,56
85714	12x60	M10x100	40x60	50	6,27

08COLF4

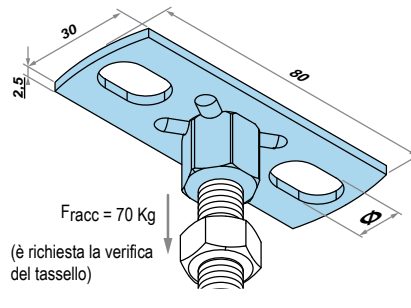



PIASTRA RETTANGOLARE DI FISSAGGIO

• Materiale: Acciaio inox AISI 304 EN 10088

CARATTERISTICHE: l'imbocco metrico è saldato a proiezione.

UTILIZZO: per il fissaggio di collari sia a parete che a solaio/pavimento. La piastra è dotata di due fori asolati, per l'inserimento di due ancoranti, e di un imbocco centrale filettato M10, per l'avvitamento di una barra filettata a passo metrico.

CODICE		asole [mm] / piastra		€ Cad.
M2513	M10	12x7,0	100	6,27

